



Construction

Vertical multi-stage pumps with suction and delivery connections of the same diameter and arranged along the same axis (in-line). Corrosion-resistant bearing sleeves lubricated by the pumped liquid. A pump with thrust bearing and sleeve coupling for use of any standard motor with IM V1 construction.

Applications

For water supply systems.
For clean non-explosive liquids, without solid, filamentary or abrasive matter (with adaptation of sealing materials on request). A universal pump for civil and industrial use, for pressure-boosting systems, fire-extinguishing systems, high-pressure washing plants, irrigation, agricultural uses and sport installations.

Operating conditions

Temperature of liquid: from -15 °C to +110 °C.
Operating environment temperature: up to 40 °C.
Maximum permissible pressure in pump casing: 25 bar.

Motor

Standard-type: 2-4 pole induction motor, 50 Hz.
Construction IM V1 (EN 60034-7).
Classification scheme IE2 for three-phase motors from 0,75 kW.
Insulation class F.
Protection IP 55.
three-phase with rated voltage: up to 3 kW 230/400 V;
from 4 kW 400/690 V.
Rated speed of rotation (50 Hz): **MXV** = 2900 rpm
MXV4 = 1450 rpm.

MXV 25-2, 32-4, 40-8

All parts that come into contact with the liquid, including wet-end covers, are in chrome-nickel stainless steel AISI 304.

Materials (wetted parts)

Component	Material
Flange External jacket Suction casing Delivery casing Stage casing Impeller Lower cover Upper cover Spacer sleeve	Chrome-nickel steel 1.4301 EN 10088 (AISI 304)
Pump shaft Plug	Chrome-nickel steel 1.4305 EN 10088 (AISI 303)
Bearing sleeve Bearing in stage casing	Corrosion-resistant, cemented carbide Ceramic alumina
Mechanical seal ISO 3069 - KU	Hard metal/Carbon/EPDM.
Wear ring	PTFE
O-rings	NBR

Direction of rotation: clockwise as seen from the motor.

Variants (to be specified when ordering)

Pump with threaded ports (G).
Pump with flanged ports (F).
Pump without motor.
Pump with standard motor.

Other variants (on request)

With counter-flanges in chrome-nickel steel.
O-rings FPM. Other mechanical seal.
Pump with motor of Client's choice (if available).
Single-phase motor 230 V, up to 2.2 kW.
Other voltage ratings. Frequency 60 Hz.
Higher or lower liquid or ambient temperatures.
Motor suitable operation with frequency converter (standard feature for MXV4).

MXV 50-16, 65-32, 80-48

Internal parts in contact with the liquid in chrome-nickel stainless steel, AISI 304 with pump casing and upper cover in cast iron.

Materials (wetted parts)

Component	Material
Pump casing Upper cover	Cast iron GJL 250 EN 1561
External jacket Stage casing Impeller Spacer sleeve	Chrome-nickel steel 1.4301 EN 10088 (AISI 304)
Pump shaft Plug	Chrome-nickel steel 1.4305 EN 10088 (AISI 303)
Bearing sleeve Bearing in stage casing	Corrosion-resistant, cemented carbide Ceramic alumina
Mechanical seal ISO 3069 - KU	Hard metal/Carbon/EPDM
Wear ring	PTFE
O-rings	NBR

Direction of rotation: anticlockwise as seen from the motor.

Variants (to be specified when ordering)

Pump without motor.
Pump with standard motor.

Other variants (on request)

O-rings FPM. Other mechanical seal.
Pump with motor of Client's choice (if available).
Other voltage ratings. Frequency 60 Hz.
Pump with support feet for horizontal installation (H1 or H2).
Support feet for horizontal installation, set.
Welding counter-flanges, PN 25 (steel).
Higher or lower liquid or ambient temperatures.
Motor suitable operation with frequency converter (standard feature for MXV4).

MXV 25-2, 32-4, 40-8

Designation

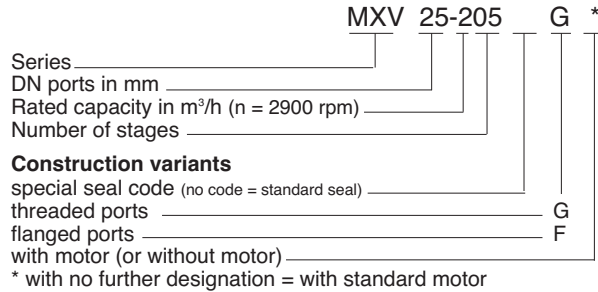

MXV 50-16, 65-32, 80-48

Designation

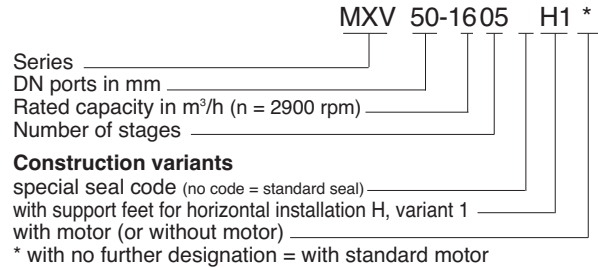

Pipe connection

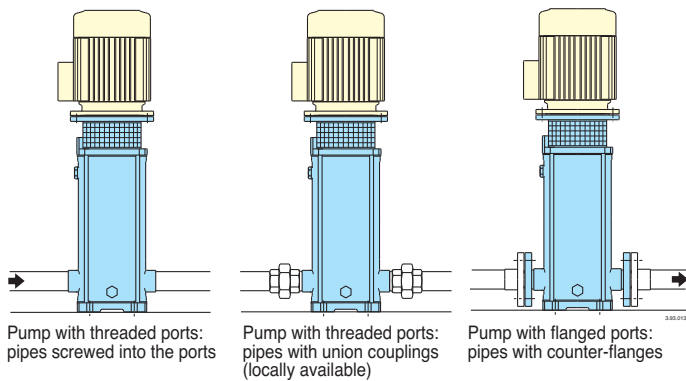

Installations

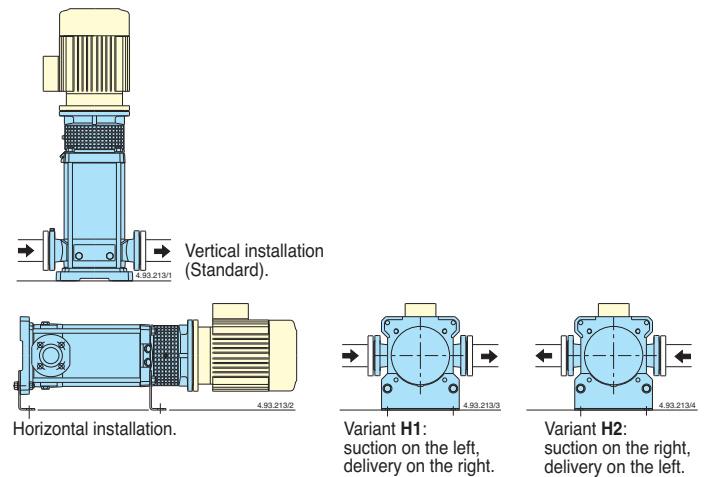

Variable parts

Pump size MXV - MXV4			Number of stages	Stage casings with bearing
25 - 204	32 - 404	40 - 804	4	1
25 - 205	32 - 405	40 - 805	5	1
25 - 206	32 - 406	40 - 806	6	1
25 - 207	32 - 407	40 - 807	7	1
25 - 208	32 - 408	40 - 808	8	1
25 - 210	32 - 410	40 - 810	10	1
25 - 212	32 - 412	40 - 811	11	2
		40 - 813	12	2
		40 - 815	13	2
25 - 214	32 - 414	40 - 815	14	2
		40 - 815	15	2
25 - 216	32 - 416		16	2
25 - 218	32 - 418		18	2
25 - 220		40 - 817	17	3
		40 - 819	19	3
		40 - 819	20	3

Variable parts

Pump size MXV - MXV4			Number of stages	Stage casings with bearing
50 - 1603 50 - 1604 50 - 1605 50 - 1606 50 - 1607 50 - 1608 50 - 1609 50 - 1610	65 - 3202	80 - 4801	1	1
	65 - 3203	80 - 4802	2	1
	65 - 3204	80 - 4803	3	1
	65 - 3205	80 - 4804	4	1
	65 - 3206	80 - 4805	5	1
	65 - 3207		6	1
			7	1
			8	1
			9	1
			10	1
50 - 1611 50 - 1612 50 - 1614 50 - 1616	65 - 3208	80 - 4806	6	2
	65 - 3209	80 - 4807	7	2
	65 - 3210	80 - 4808	8	2
			9	2
			10	2
			11	2
			12	2
			14	2
		16	2	

Coverage chart

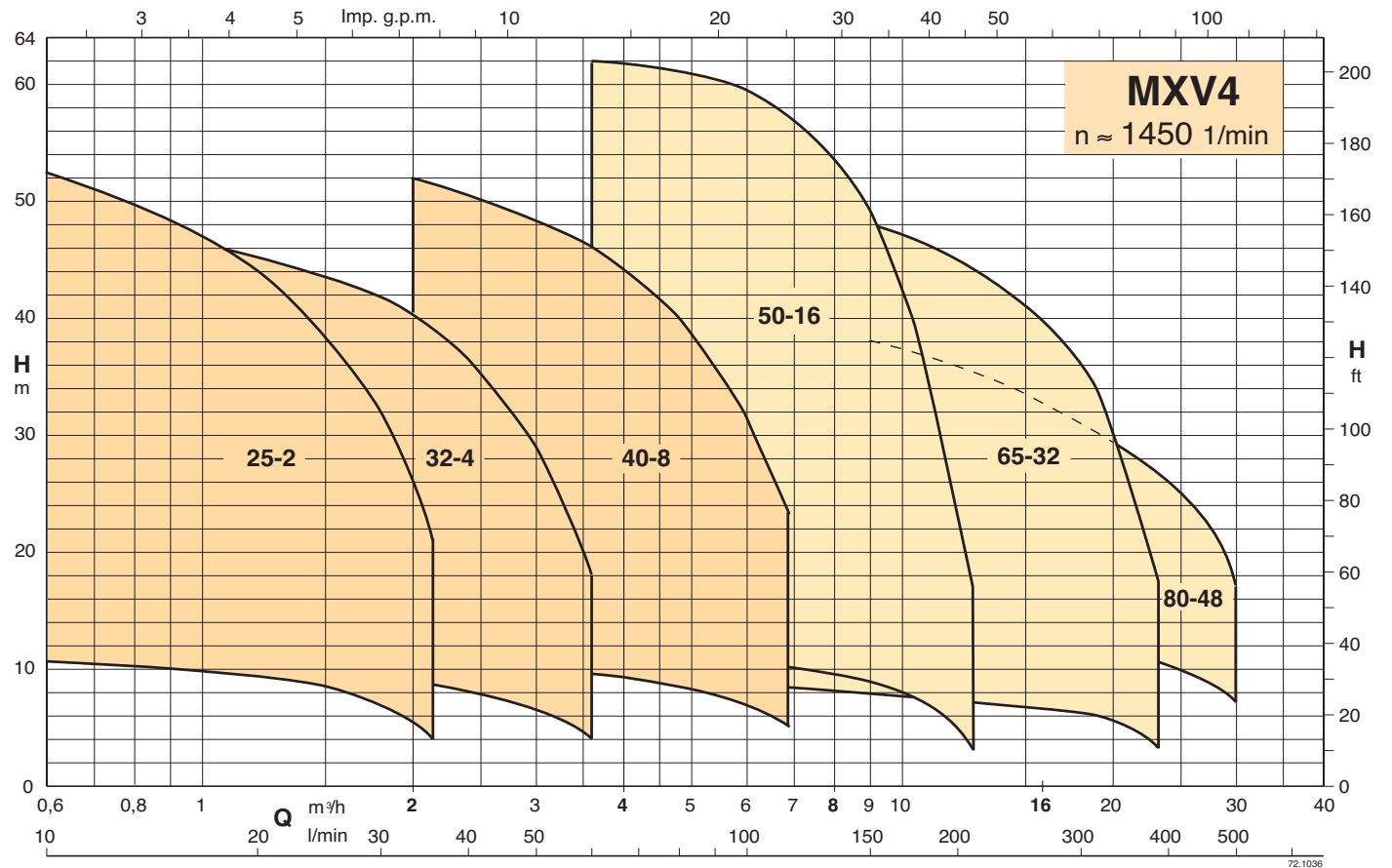
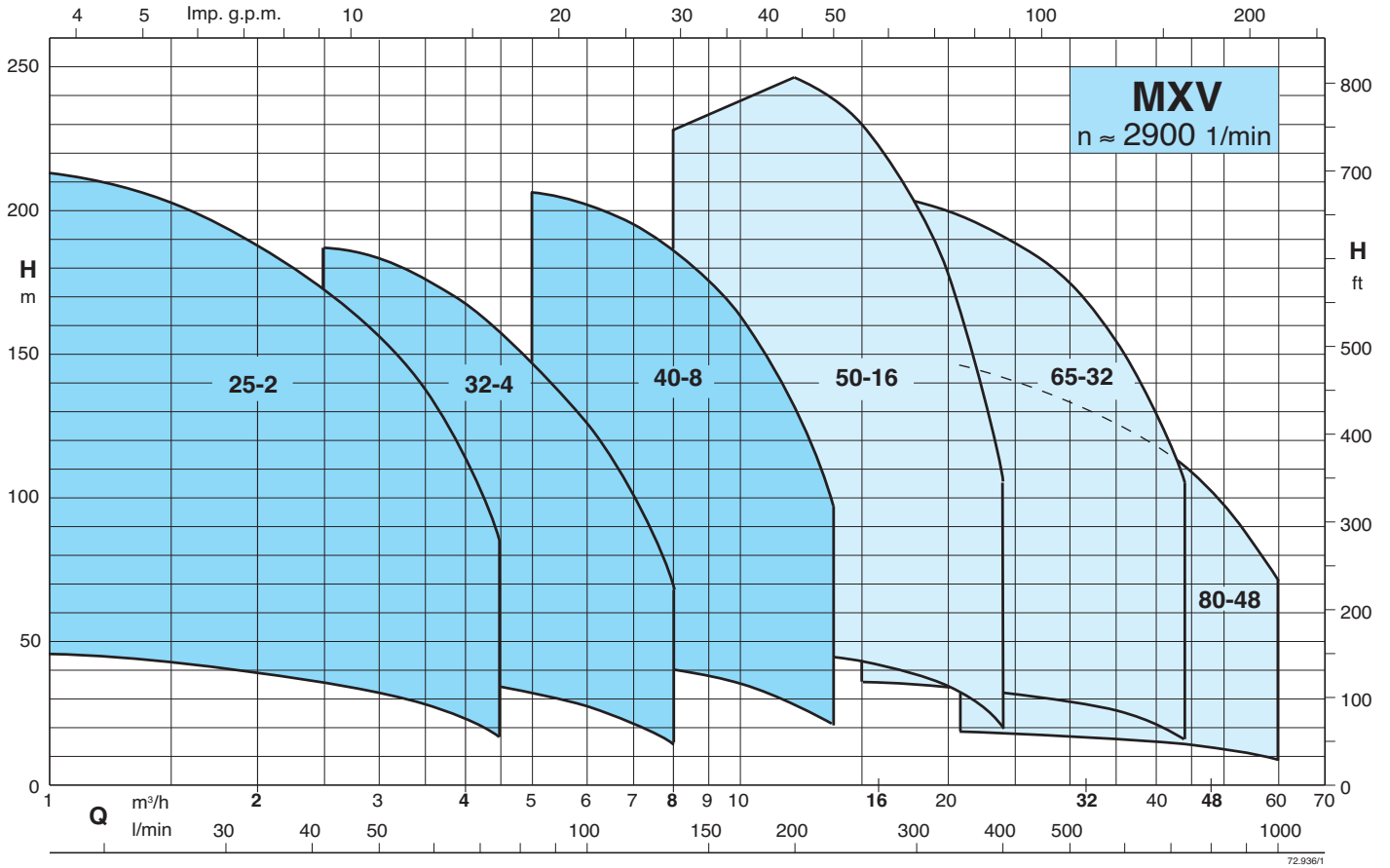

Characteristic curves and performance $n \approx 2900$ rpm

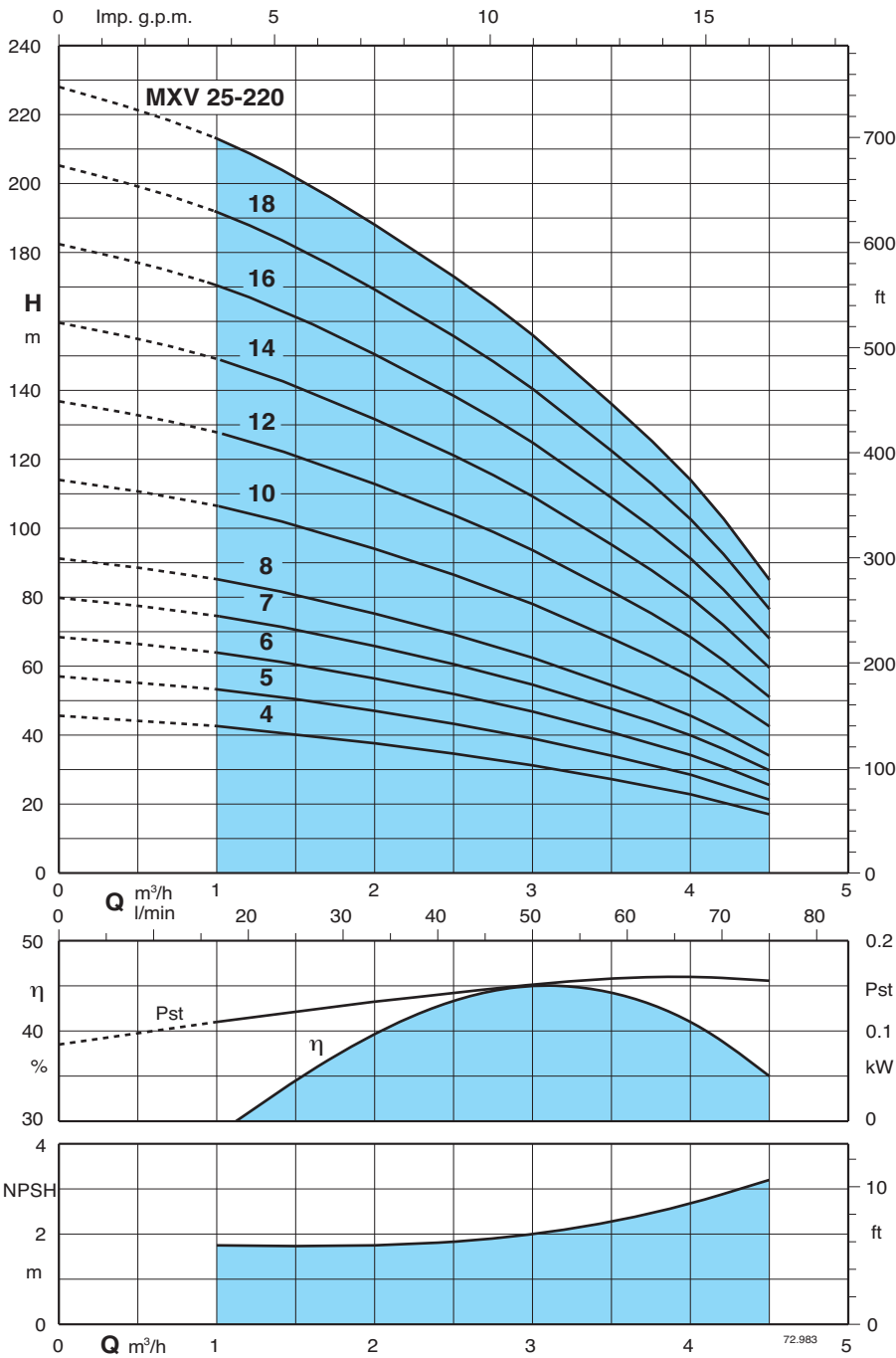

Test results with clean cold water, without gas content.

A safety margin of + 0.5 m is recommended for the NPSH value.

Tolerances in accordance with ISO 9906, Annex A.

Head and power values valid for liquids with density $\rho = 1,0 \text{ kg/dm}^3$ and kinematic viscosity $\nu = \text{max } 20 \text{ mm}^2/\text{sec}$.

Pst = Power with reference to one stage.

A* Calpeda motor currents

Pump type	230 V		400 V		Motor power		Q m³/h l/min									
	A*	A*	A*	A*	kW	HP		0	1	1,5	2	2,5	3	3,5	4	4,5
MXV 25-204/C	3,3	1,9	0,75	1	H m	0	0	16,6	25	33,3	41,6	50	58,3	66,6	75	
MXV 25-205/C	3,3	1,9	0,75	1		44	42,5	40	37,5	34,5	31	27	22,5	17		
MXV 25-206/C	5,2	3	1,1	1,5		56	53	50	47	43	39	34	28	21		
MXV 25-207/C	5,2	3	1,1	1,5		68	63,5	60,5	56	51,5	46,5	40,5	34	25		
MXV 25-208/C	7,4	4,3	1,5	2		79,5	74	70,5	65,5	60	54,5	47,5	39,5	30		
MXV 25-210/C	7,4	4,3	1,5	2		91	85	80,5	75	69	62	54	45,5	34		
MXV 25-212/C	9,5	5,5	2,2	3		114	106	101	94	86	78	68	57	42		
MXV 25-214/C	9,5	5,5	2,2	3		136	127	121	112	103	93,5	81,5	68	51		
MXV 25-216/C	11,4	6,6	3	4		159	149	141	131	121	109	95	79,5	59		
MXV 25-218/C	11,4	6,6	3	4		182	170	161	150	138	124	108	91	68		
MXV 25-220/C	11,4	6,6	3	4		205	191	181	169	155	140	122	102	76		
						228	213	202	188	173	156	136	114	85		

Characteristic curves and performance $n \approx 2900$ rpm

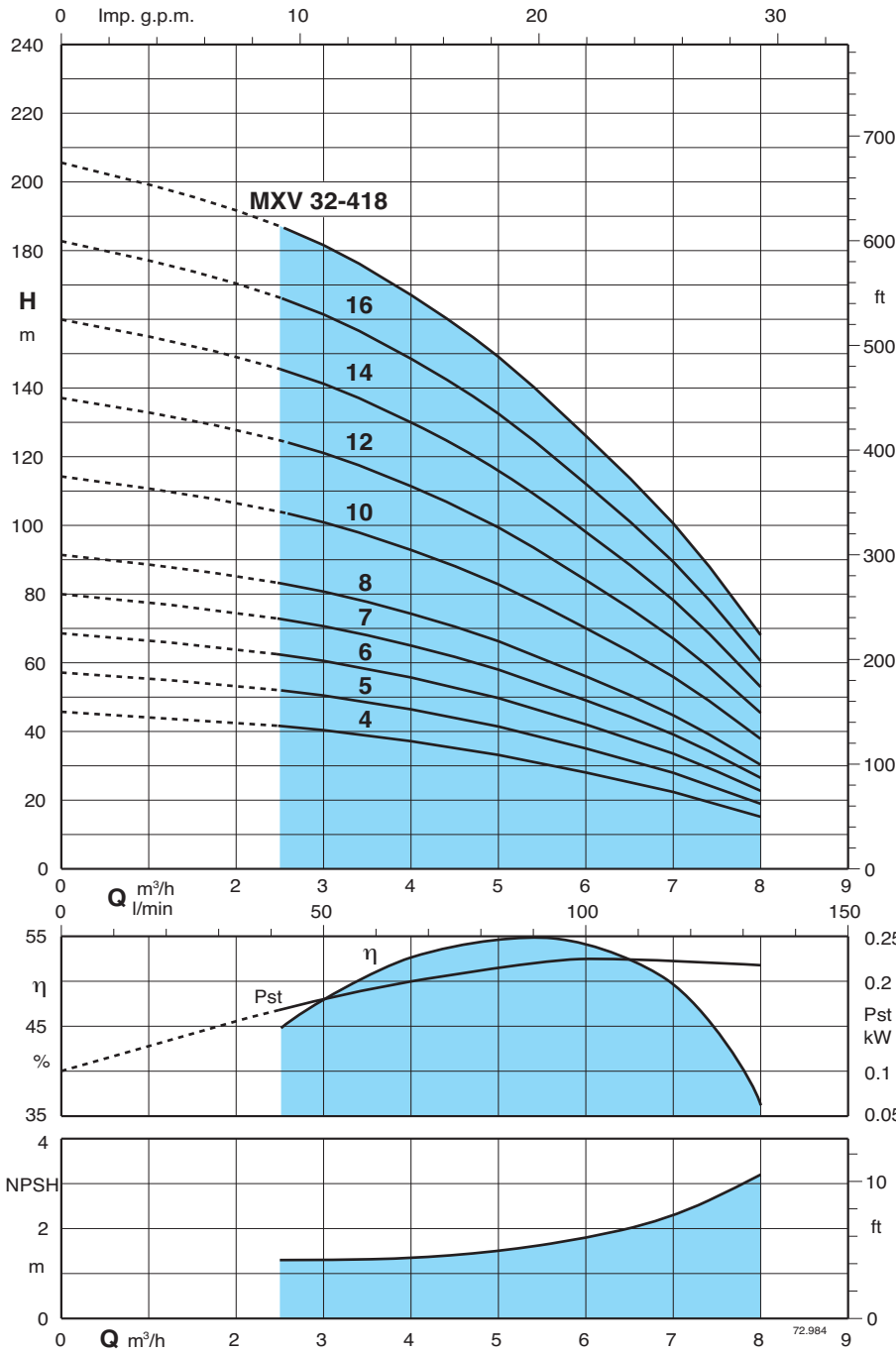

Test results with clean cold water, without gas content.
 A safety margin of + 0.5 m is recommended for the NPSH value.
 Tolerances in accordance with ISO 9906, Annex A.

Head and power values valid for liquids with density $\rho = 1,0 \text{ kg/dm}^3$ and kinematic viscosity $\nu = \text{max } 20 \text{ mm}^2/\text{sec}$.

Pst = Power with reference to one stage.
 A* Calpeda motor currents

Pump type	230 V		400 V		Motor power		Q m³/h l/min	H m									
	A*	A*	A*	A*	kW	HP		0	2,5	3	3,5	4	4,5	5	6	7	8
MXV 32-404/C	5,2	3	1,1	1,5	0	0	0	41,6	50	58,3	66,6	75	83,3	100	116,6	133,3	
MXV 32-405/C	5,2	3	1,1	1,5	45	45	45	41,5	40	38,5	36,5	34,5	32,5	27,5	22	14,5	
MXV 32-406/C	7,4	4,3	1,5	2	56	56	56	51,5	50	48	46	43,5	41	34,5	27,5	18,5	
MXV 32-407/C	7,4	4,3	1,5	2	68	68	68	62	60	58	55,5	52,5	49,5	42	33,5	22,5	
MXV 32-408/C	9,5	5,5	2,2	3	79,5	79,5	79,5	72,5	70,5	68	65	61,5	58	49	39	26,5	
MXV 32-410/C	9,5	5,5	2,2	3	91	91	91	83	80,5	78	74	70	66	56	44,5	30	
MXV 32-412/C	11,4	6,6	3	4	114	114	114	104	101	97,5	93	88	83	70	56	38	
MXV 32-414/C	11,4	6,6	3	4	136	136	136	124	121	117	111	105	99,5	84	67	45,5	
MXV 32-416/C		9,6	4	5,5	159	159	159	145	141	136	130	123	116	98	78	53	
MXV 32-418/C		9,6	4	5,5	182	182	182	166	161	156	148	140	132	112	89,5	60,5	
					205	205	205	187	181	175	167	158	149	126	100	68	

Characteristic curves and performance $n \approx 2900$ rpm

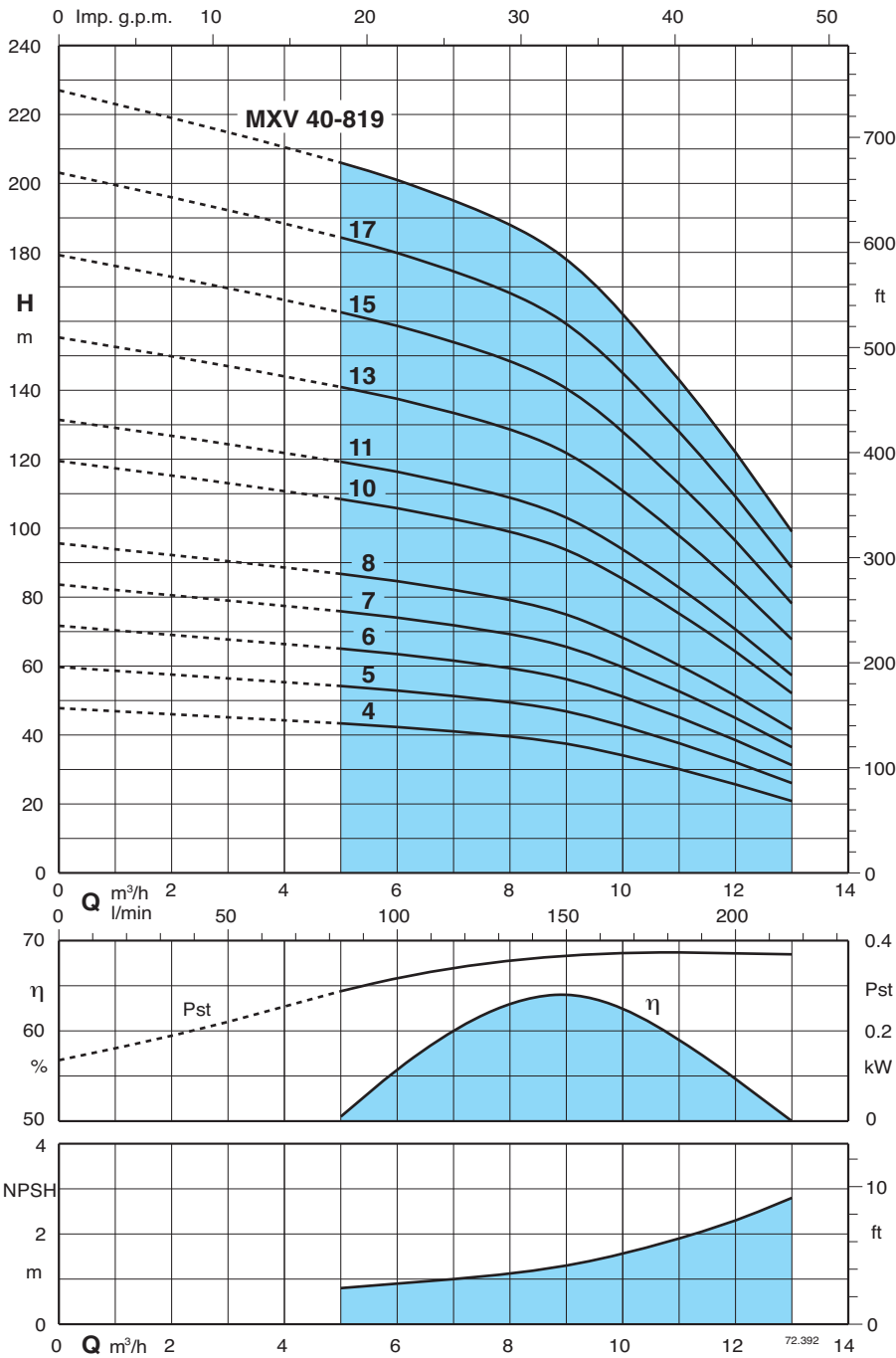

Test results with clean cold water, without gas content.

A safety margin of + 0.5 m is recommended for the NPSH value.

Tolerances in accordance with ISO 9906, Annex A.

Head and power values valid for liquids with density $\rho = 1,0 \text{ kg/dm}^3$ and kinematic viscosity $\nu = \text{max } 20 \text{ mm}^2/\text{sec}$.

Pst = Power with reference to one stage.

A* Calpeda motor currents

Pump type	230 V		400 V		Motor power		Q m³/h l/min	H												
	A*	A*	A*	A*	kW	HP		0	5	6	7	8	9	10	11	12	13			
MXV 40-804/C	7,4	4,3	1,5	2			0	0	83,3	100	116,6	133,3	150	166,6	183,3	200	216,6			
MXV 40-805/C	9,5	5,5	2,2	3			47	43	42	41	40	37	34	30	26	21				
MXV 40-806/C	9,5	5,5	2,2	3			59	54	53	51	50	47	43	38	32	26				
MXV 40-807/C	11,4	6,6	3	4			71	65	63	62	59	56	51	45	39	31				
MXV 40-808/C	11,4	6,6	3	4			83	76	74	72	69	66	60	53	45	36				
MXV 40-810/C		9,6	4	5,5			95	87	85	82	79	75	69	60	51	42				
MXV 40-811/C		9,6	4	5,5			119	109	106	103	99	94	86	75	64	52				
MXV 40-813/C		10,9	5,5	7,5			131	119	116	113	109	103	94	83	71	57				
MXV 40-815/C		10,9	5,5	7,5			155	141	138	134	129	122	111	98	84	68				
MXV 40-817/C		14,3	7,5	10			179	163	159	154	149	141	128	113	96	78				
MXV 40-819/C		14,3	7,5	10			202	184	180	175	168	159	145	128	109	89				
							226	206	201	195	188	178	162	143	122	99				

Characteristic curves and performance $n \approx 2900$ rpm

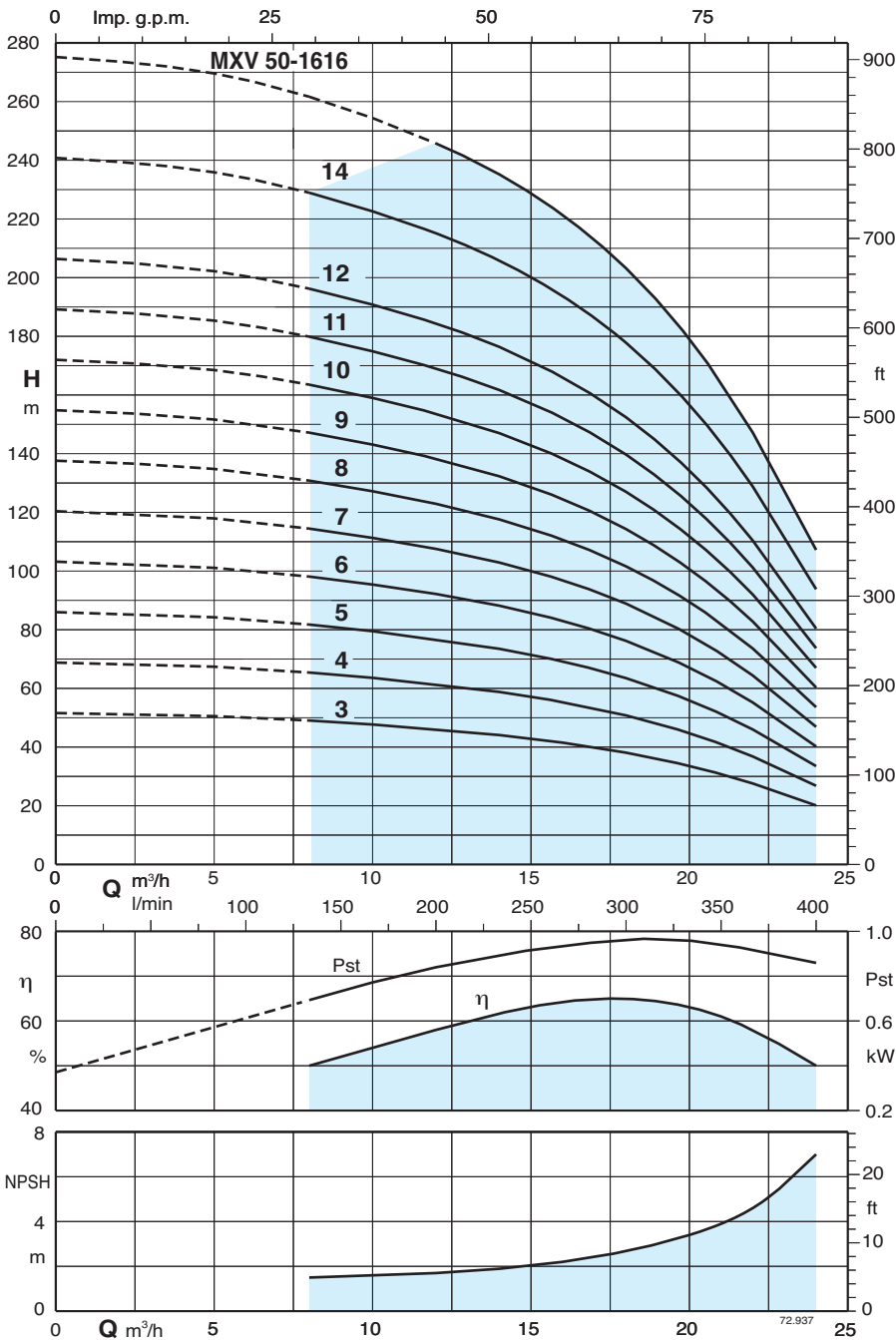

Test results with clean cold water, without gas content.

A safety margin of + 0.5 m is recommended for the NPSH value.

Tolerances in accordance with ISO 9906, Annex A.

Head and power values valid for liquids with density $\rho = 1,0 \text{ kg/dm}^3$ and kinematic viscosity $\nu = \text{max } 20 \text{ mm}^2/\text{sec}$.

Pst = Power with reference to one stage.

Pump type	230 V		400 V		Motor power kW HP	Q m³/h l/min	0	8	10	12	14	16	18	20	22	24
	A*	A*	0	133,3			166,6	200	233	266	300	333	366	400		
MXV 50-1603/C	11,4	6,6	3	4	H m	51	49	48	46	44	41	38	33	27	20	
MXV 50-1604/C		9,6	4	5,5		69	65	63	61	59	55	51	44	37	27	
MXV 50-1605/C		10,9	5,5	7,5		86	81	79	76	73	69	63	55	46	33	
MXV 50-1606/C		10,9	5,5	7,5		103	98	95	92	88	83	76	67	55	40	
MXV 50-1607/C		14,3	7,5	10		120	114	111	107	103	97	89	78	64	47	
MXV 50-1608/C		14,3	7,5	10		138	130	127	122	117	110	101	89	73	53	
MXV 50-1609/C		21,5	11	15		155	147	143	138	132	124	114	100	83	60	
MXV 50-1610/C		21,5	11	15		172	163	159	153	147	138	127	111	92	67	
MXV 50-1611/C		21,5	11	15		189	179	175	168	161	152	139	122	101	73	
MXV 50-1612/C		27,3	15	20		206	196	190	184	176	166	152	133	110	80	
MXV 50-1614/C		27,3	15	20		240	228	222	214	206	193	178	156	129	94	
MXV 50-1616/C		34	18,5	25		275			245	235	221	203	178	147	107	

Characteristic curves and performance $n \approx 2900$ rpm

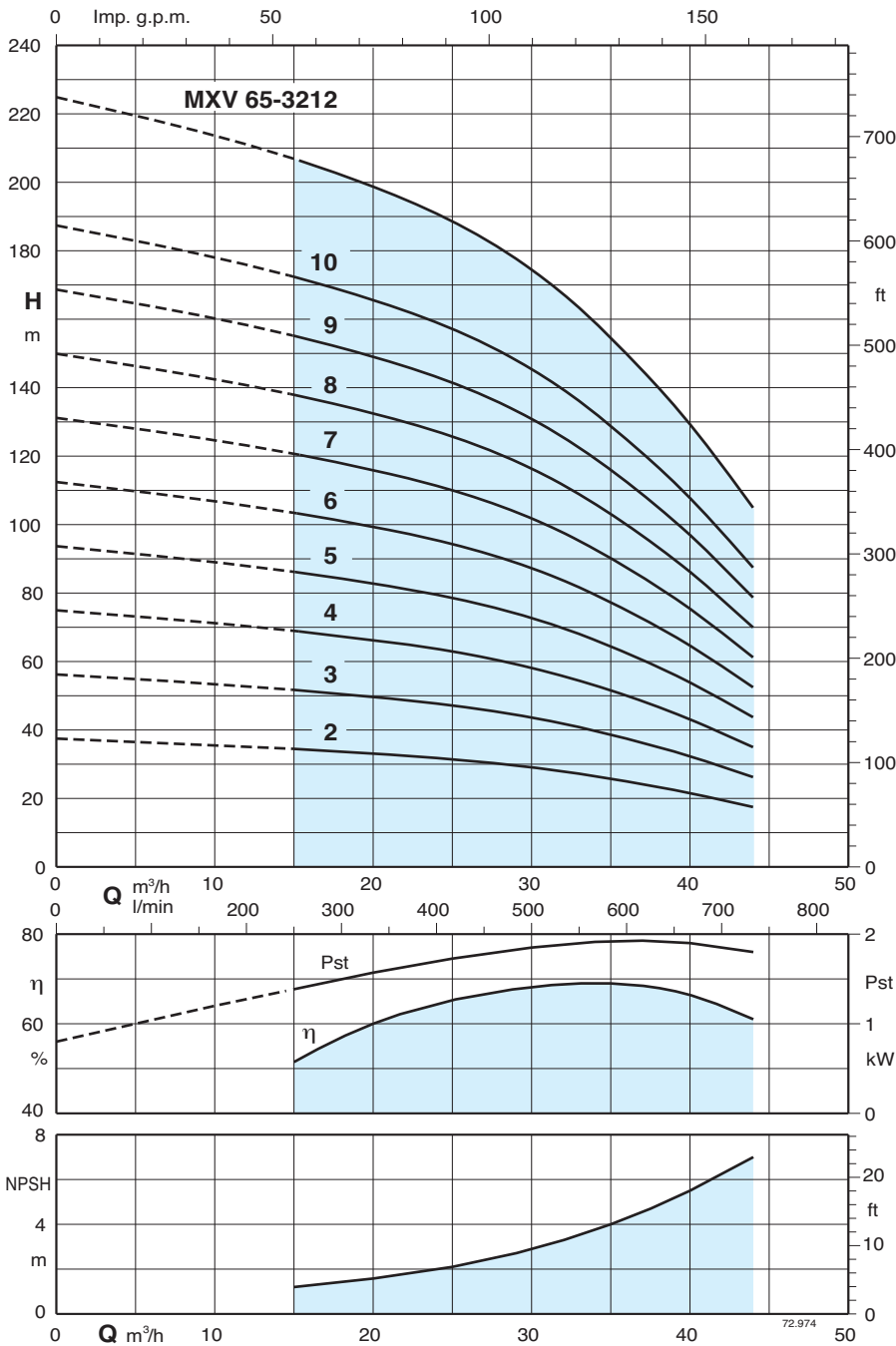

Test results with clean cold water, without gas content.

A safety margin of + 0.5 m is recommended for the NPSH value.

Tolerances in accordance with ISO 9906, Annex A.

Head and power values valid for liquids with density $\rho = 1,0 \text{ kg/dm}^3$ and kinematic viscosity $\nu = \text{max } 20 \text{ mm}^2/\text{sec}$.

Pst = Power with reference to one stage.

A* Calpeda motor currents

Pump type	230 V		400 V		Motor power	Q	m³/h													
	A*	A*	kW	HP			0	15	21	24	27	30	33	36	39	44				
MXV 65-3202/C			9,6	4	5,5	H m	0	250	350	400	450	500	550	600	650	733				
MXV 65-3203/C			10,9	5,5	7,5		37	34	32	31	30	29	27	24,5	22	17				
MXV 65-3204/C			14,3	7,5	10		55,5	51	49	47,5	46	43,5	40,5	37	33,5	25,5				
MXV 65-3205/C			21,5	11	15		75	69	65,5	63,5	61	58,5	54,5	50	45	35				
MXV 65-3206/C			21,5	11	15		93,5	86	82	79,5	77	73	68	62,5	56,5	44				
MXV 65-3207/C			27,3	15	20		112	103	98,5	95,5	92	87	82	75	67,5	52,5				
MXV 65-3208/C			27,3	15	20		131	121	115	111	107	102	95,5	87,5	79	61,5				
MXV 65-3209/C			34	18,5	25		150	138	131	127	123	116	109	100	90	70				
MXV 65-3210/C			34	18,5	25		168	155	148	143	138	130	122	112	101	79				
MXV 65-3212/C			41	22	30		187	172	164	159	154	145	136	125	112	87,5				
						225	207	197	191	185	174	163	150	135	105					

Characteristic curves and performance $n \approx 2900$ rpm

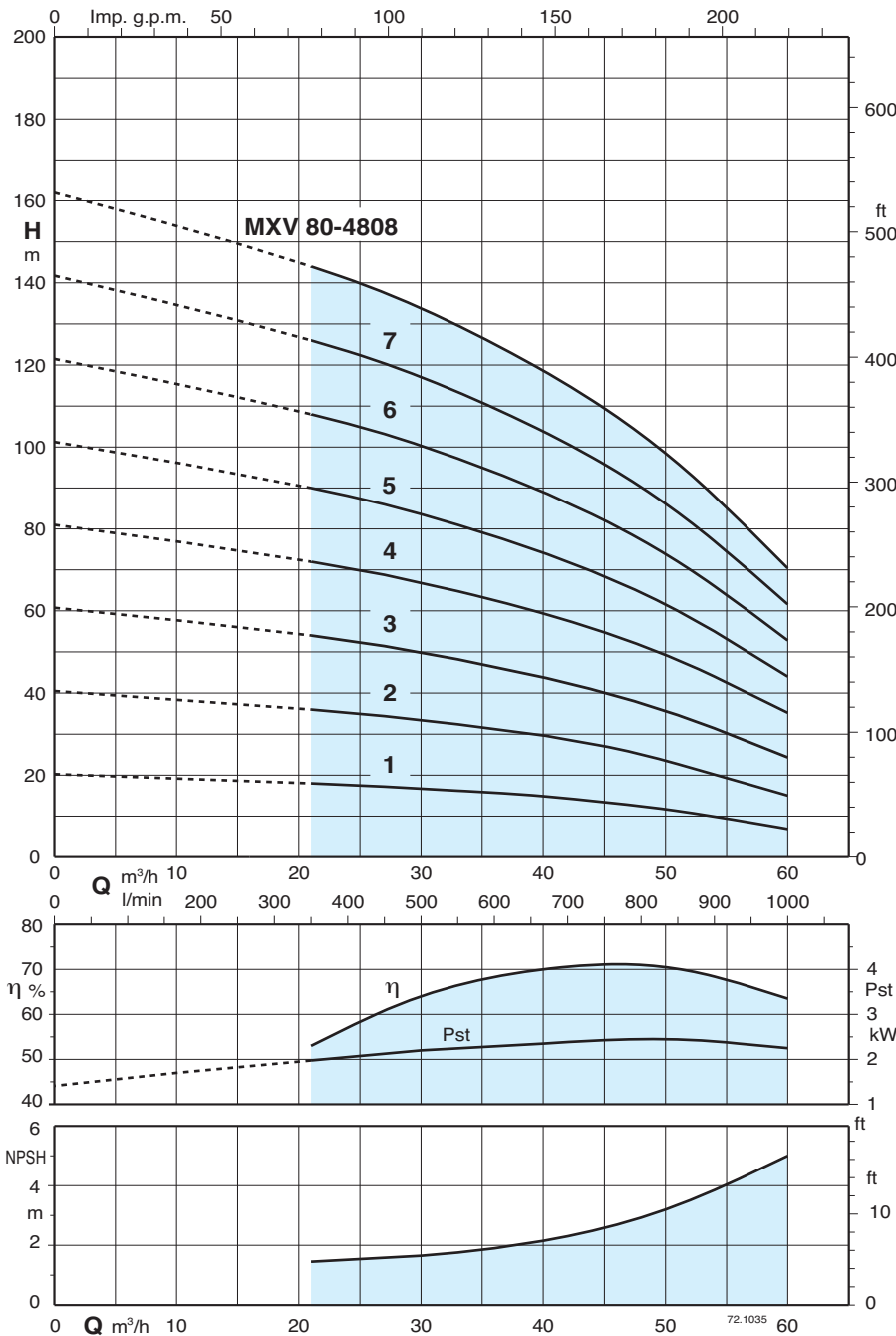

Test results with clean cold water, without gas content.

A safety margin of + 0.5 m is recommended for the NPSH value.

Tolerances in accordance with ISO 9906, Annex A.

Head and power values valid for liquids with density $\rho = 1,0 \text{ kg/dm}^3$ and kinematic viscosity $\nu = \text{max } 20 \text{ mm}^2/\text{sec}$.

Pst = Power with reference to one stage.

A* Calpeda motor currents

Pump type	230 V		400 V		Motor power		Q m³/h l/min	H m									
	A*	A*	A*	A*	kW	HP		0	21	27	33	39	45	48	51	54	60
MXV 80-4801/C			9,6		4	5,5	0	0	350	450	550	650	750	800	850	900	1000
MXV 80-4802/C			10,9		5,5	7,5	20	18	17	16	15	13	12	10,7	9,5	7	
MXV 80-4803/C			14,3		7,5	10	40,5	36	34,5	32,5	29,5	26,5	24,5	22	20	15,5	
MXV 80-4804/C			21,5		11	15	61	54	51	48	44	40	37	34	31	24,5	
MXV 80-4805/C			27,3		15	20	81	72	69	65	60	55	51,5	48	44	35	
MXV 80-4806/C			27,3		15	20	101	90	86	81	75	68,5	64,5	60	55	44	
MXV 80-4807/C			34		18,5	25	121	108	103	97	90	82	77,5	72	66	53	
MXV 80-4808/C			41		22	30	142	126	120	113	105	96	90	84	77	61,5	
							162	144	137	129	120	109	103	96	88	70,5	

Dimensions and weights

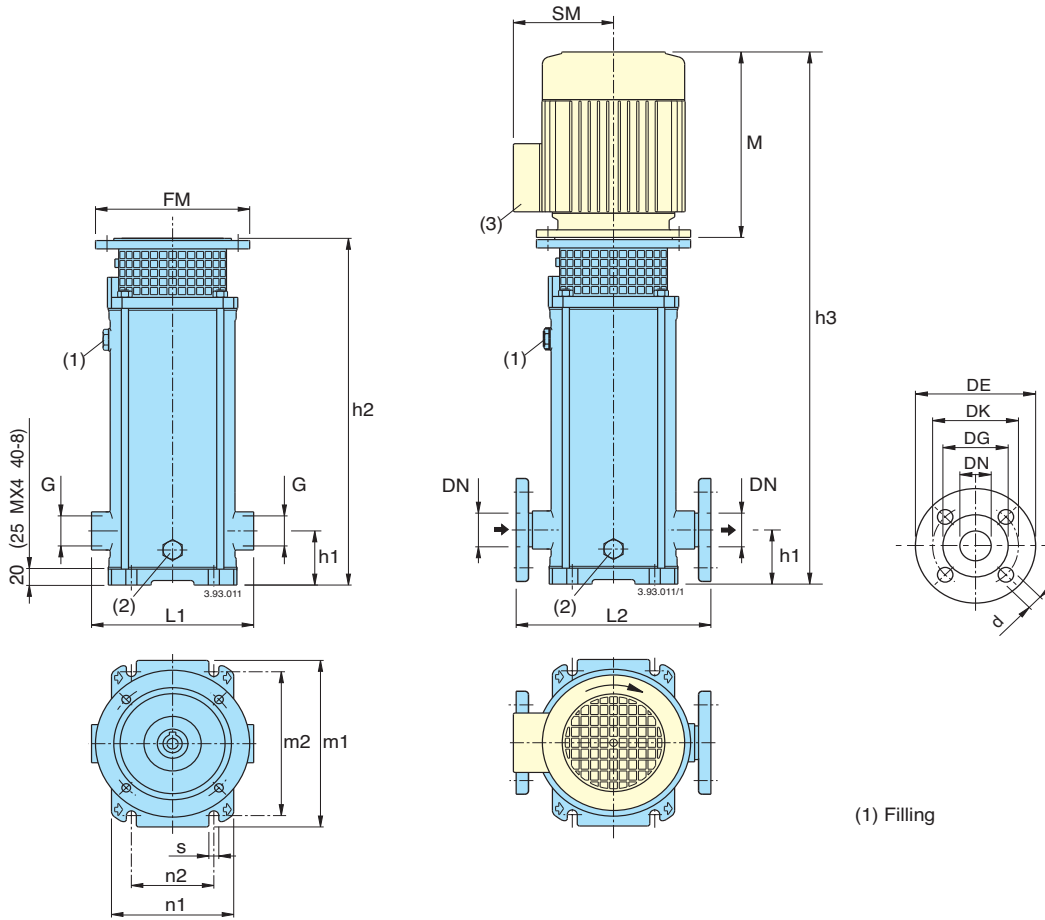

Counterflanges in stainless steel

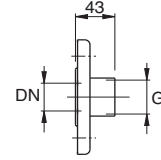

DN	G ISO 228
25	1
32	1 1/4
40	1 1/2

Flanges EN 1092-1 PN 25 - 40

DN	DE	DK	DG	Holes	
				N.	Ø
25	115	85	65	4	14
32	140	100	76	4	19
40	150	110	84	4	19

(1) Filling

(2) Draining

Pump	Motor			MXV (G)		MXV (F)		mm										without motor	with motor	
				threaded ports		flanged ports												MXV (G)	with motor	
				G ISO 228	L1	DN	L2	h1	h2	(5) M	h3	FM	(5) SM	m1	m2	n1	n2	s	(4) kg(6)	(5) kg(6)
MXV 25-204/C	0,75	1	M80 V1	G1	215	25	250	75	372	255	627	200	127,5	210	180	150	100	12,5	18	30,2
MXV 25-205/C	0,75	1	M80 V1	G1	215	25	250	75	396	255	651	200	127,5	210	180	150	100	12,5	19	31,2
MXV 25-206/C	1,1	1,5	M80 V1	G1	215	25	250	75	420	255	675	200	127,5	210	180	150	100	12,5	20	33,3
MXV 25-207/C	1,1	1,5	M80 V1	G1	215	25	250	75	444	255	699	200	127,5	210	180	150	100	12,5	21	34,3
MXV 25-208/C	1,5	2	M90 V1	G1	215	25	250	75	478	255	733	200	127,5	210	180	150	100	12,5	22	37,2
MXV 25-210/C	1,5	2	M90 V1	G1	215	25	250	75	526	255	781	200	127,5	210	180	150	100	12,5	23	38,2
MXV 25-212/C	2,2	3	M90 V1	G1	215	25	250	75	574	295	869	200	127,5	210	180	150	100	12,5	25	43,1
MXV 25-214/C	2,2	3	M90 V1	G1	215	25	250	75	622	295	917	200	127,5	210	180	150	100	12,5	26	44,1
MXV 25-216/C	3	4	M100 V1	G1	215	25	250	75	680	311	991	250	137,5	210	180	150	100	12,5	29	54,6
MXV 25-218/C	3	4	M100 V1	G1	215	25	250	75	728	311	1039	250	137,5	210	180	150	100	12,5	31	56,6
MXV 25-220/C	3	4	M100 V1	G1	215	25	250	75	776	311	1087	250	137,5	210	180	150	100	12,5	32	57,6
MXV 32-404/C	1,1	1,5	M80 V1	G 1 1/4	215	32	250	75	372	255	627	200	127,5	210	180	150	100	12,5	19	31,2
MXV 32-405/C	1,1	1,5	M80 V1	G 1 1/4	215	32	250	75	396	255	651	200	127,5	210	180	150	100	12,5	20	32,2
MXV 32-406/C	1,5	2	M90 V1	G 1 1/4	215	32	250	75	430	255	685	200	127,5	210	180	150	100	12,5	21	36,2
MXV 32-407/C	1,5	2	M90 V1	G 1 1/4	215	32	250	75	454	255	709	200	127,5	210	180	150	100	12,5	22	37,2
MXV 32-408/C	2,2	3	M90 V1	G 1 1/4	215	32	250	75	478	295	773	200	127,5	210	180	150	100	12,5	23	41,1
MXV 32-410/C	2,2	3	M90 V1	G 1 1/4	215	32	250	75	526	295	821	200	127,5	210	180	150	100	12,5	24	42,1
MXV 32-412/C	3	4	M100 V1	G 1 1/4	215	32	250	75	584	311	895	250	137,5	210	180	150	100	12,5	27	52,6
MXV 32-414/C	3	4	M100 V1	G 1 1/4	215	32	250	75	632	311	943	250	137,5	210	180	150	100	12,5	29	54,6
MXV 32-416/C	4	5,5	M112 V1	G 1 1/4	215	32	250	75	680	311	991	250	137,5	210	180	150	100	12,5	30	57,8
MXV 32-418/C	4	5,5	M112 V1	G 1 1/4	215	32	250	75	728	311	1039	250	137,5	210	180	150	100	12,5	31	58,8
MXV 40-804/C	1,5	2	M90 V1	G 1 1/2	225	40	280	80	411	255	666	200	127,5	246	215	190	130	14	21	36,2
MXV 40-805/C	2,2	3	M90 V1	G 1 1/2	225	40	280	80	441	295	736	200	127,5	246	215	190	130	14	22	40,1
MXV 40-806/C	2,2	3	M90 V1	G 1 1/2	225	40	280	80	471	295	766	200	127,5	246	215	190	130	14	23	41,1
MXV 40-807/C	3	4	M100 V1	G 1 1/2	225	40	280	80	511	311	822	250	137,5	246	215	190	130	14	25	50,6
MXV 40-808/C	3	4	M100 V1	G 1 1/2	225	40	280	80	541	311	852	250	137,5	246	215	190	130	14	26	51,6
MXV 40-810/C	4	5,5	M112 V1	G 1 1/2	225	40	280	80	601	311	912	250	137,5	246	215	190	130	14	28	55,8
MXV 40-811/C	4	5,5	M112 V1	G 1 1/2	225	40	280	80	631	311	942	250	137,5	246	215	190	130	14	29	56,8
MXV 40-813/C	5,5	7,5	M132 V1	G 1 1/2	225	40	280	80	711	339	1050	300	159,5	246	215	190	130	14	35	77,3
MXV 40-815/C	5,5	7,5	M132 V1	G 1 1/2	225	40	280	80	771	339	1110	300	159,5	246	215	190	130	14	36	78,3
MXV 40-817/C	7,5	10	M132 V1	G 1 1/2	225	40	280	80	831	339	1170	300	159,5	246	215	190	130	14	38	85,7
MXV 40-819/C	7,5	10	M132 V1	G 1 1/2	225	40	280	80	891	339	1230	300	159,5	246	215	190	130	14	39	86,7

(3) Standard position of terminal box. (for other positions rotate motor through 90° or 180°)

(4) MXV (F) = MXV (G) + 1kg

(5) With standard motor

(6) Net weight

Dimensions and weights

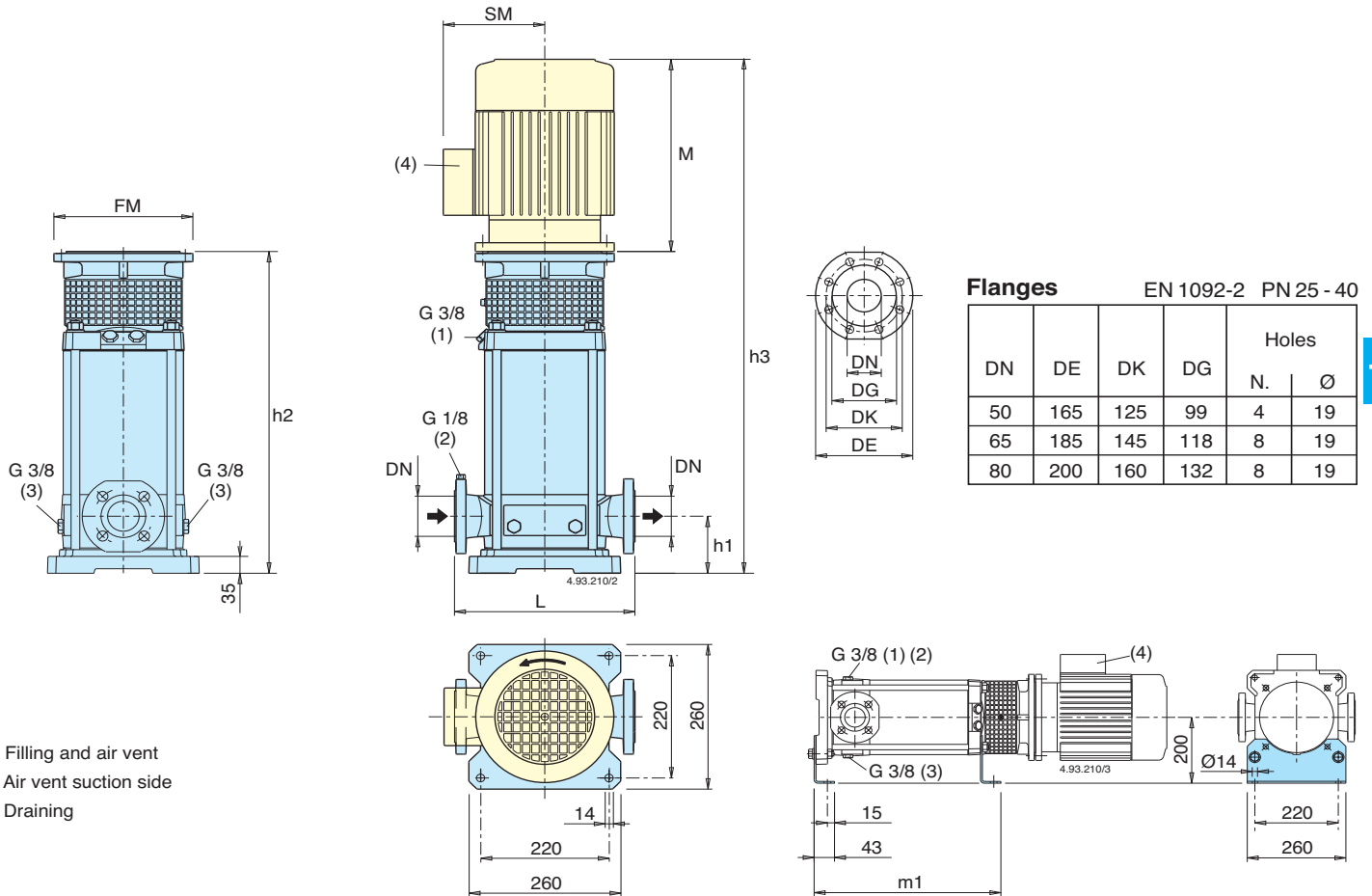

- (1) Filling and air vent
- (2) Air vent suction side
- (3) Draining

Pump	Motor			mm									without motor	with motor
				DN	L	h1	h2	(6) M	h3	FM	(6) SM	m1	MXV (5) kg (7)	(6) kg (7)
MXV 50-1603/C	3	4	M100 V1	50	300	90	395	311	706	250	137,5	322	42	67,6
MXV 50-1604/C	4	5,5	M112 V1	50	300	90	430	311	741	250	137,5	357	43	70,8
MXV 50-1605/C	5,5	7,5	M132 V1	50	300	90	484	339	823	300	159,5	391	49	91,3
MXV 50-1606/C	5,5	7,5	M132 V1	50	300	90	519	339	858	300	159,5	426	51	93,3
MXV 50-1607/C	7,5	10	M132 V1	50	300	90	553	339	892	300	159,5	460	52	99,7
MXV 50-1608/C	7,5	10	M132 V1	50	300	90	588	339	927	300	159,5	495	53	100,7
MXV 50-1609/C	11	15	M160 V1	50	300	90	652	434	1086	350	186	529	62	138
MXV 50-1610/C	11	15	M160 V1	50	300	90	687	434	1121	350	186	564	64	140
MXV 50-1611/C	11	15	M160 V1	50	300	90	721	434	1155	350	186	598	65	141
MXV 50-1612/C	15	20	M160 V1	50	300	90	756	484	1240	350	186	633	67	169
MXV 50-1614/C	15	20	M160 V1	50	300	90	825	484	1309	350	186	702	70	172
MXV 50-1616/C	18,5	25	M160 V1	50	300	90	894	510	1404	350	186	771	73	179,5
MXV 65-3202/C	4	5,5	M112 V1	65	320	105	407	311	718	250	137,5	334	45	72,8
MXV 65-3203/C	5,5	7,5	M132 V1	65	320	105	473	339	812	300	159,5	380	51	93,3
MXV 65-3204/C	7,5	10	M132 V1	65	320	105	519	339	858	300	159,5	426	53	100,7
MXV 65-3205/C	11	15	M160 V1	65	320	105	595	434	1029	350	186	472	62	138
MXV 65-3206/C	11	15	M160 V1	65	320	105	641	434	1075	350	186	518	64	140
MXV 65-3207/C	15	20	M160 V1	65	320	105	687	484	1171	350	186	564	66	168
MXV 65-3208/C	15	20	M160 V1	65	320	105	733	484	1217	350	186	610	68	170
MXV 65-3209/C	18,5	25	M160 V1	65	320	105	779	510	1289	350	186	656	70	176,5
MXV 65-3210/C	18,5	25	M160 V1	65	320	105	825	510	1335	350	186	702	72	88,5
MXV 65-3212/C	22	30	M180 V1	65	320	105	917	538	1455	350	206	794	75	204
MXV 80-4801/C	4	5,5	M112 V1	80	320	105	411	311	722	250	137,5	338	45	72,8
MXV 80-4802/C	5,5	7,5	M132 V1	80	320	105	466	339	805	300	159,5	373	51	93,3
MXV 80-4803/C	7,5	10	M132 V1	80	320	105	527	339	866	300	159,5	434	54	101,7
MXV 80-4804/C	11	15	M160 V1	80	320	105	618	434	1052	350	186	495	64	140
MXV 80-4805/C	15	20	M160 V1	80	320	105	680	484	1164	350	186	557	66	168
MXV 80-4806/C	15	20	M160 V1	80	320	105	741	484	1225	350	186	618	69	171
MXV 80-4807/C	18,5	25	M160 V1	80	320	105	802	510	1312	350	186	679	72	178,5
MXV 80-4808/C	22	30	M180 V1	80	320	105	864	538	1402	350	206	741	74	203

(4) Standard position of terminal box. (for other positions rotate motor through 90° or 180°)

(5) MXV (L) : + 3 kg
MXV (H) : + 3 kg

(6) With standard motor

(7) Net weight

Characteristic curves and performance $n \approx 1450$ rpm

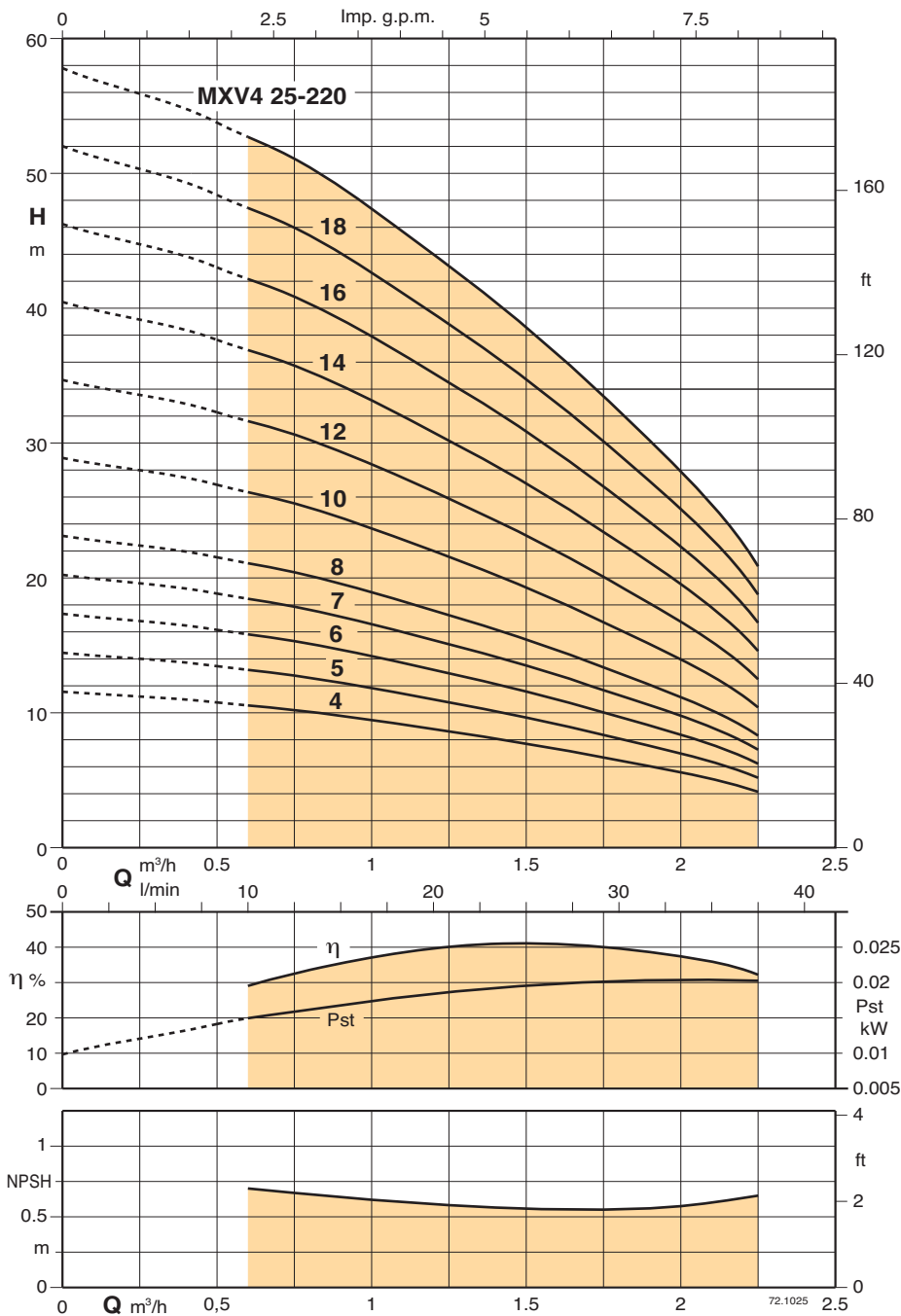

Test results with clean cold water, without gas content.

A safety margin of + 0.5 m is recommended for the NPSH value.

Tolerances in accordance with ISO 9906, Annex A.

Head and power values valid for liquids with density $\rho = 1,0 \text{ kg/dm}^3$ and kinematic viscosity $\nu = \text{max } 20 \text{ mm}^2/\text{sec}$.

Pst = Power with reference to one stage.

Pump type	Motor power		Q m³/h l/min	0	0,6	0,9	1,2	1,5	1,8	2,2		
	kW	HP		0	10	15	20	25	30	36,6		
MXV4 25-204	0,55	0,75	H m	11,5	10,5	10	9	7,5	6,5	4		
MXV4 25-205	0,55	0,75		14,5	13	12	11	9,5	8	5		
MXV4 25-206	0,55	0,75		17,5	16	14,5	13	11,5	9,5	6		
MXV4 25-207	0,55	0,75		20,5	18,5	17	15,5	13,5	11	7		
MXV4 25-208	0,55	0,75		23	21	19,5	17,5	15	13	8		
MXV4 25-210	0,55	0,75		29	26,5	24,5	22	19	16	10		
MXV4 25-212	0,55	0,75		35	31,5	29,5	26,5	23	19	12		
MXV4 25-214	0,55	0,75		40,5	37	34,5	31	26,5	22,5	14		
MXV4 25-216	0,55	0,75		46,5	42	39	35	30,5	25,5	16,5		
MXV4 25-218	0,55	0,75		52	47,5	44	39,5	34	29	18,5		
MXV4 25-220	0,55	0,75		58	52,5	49	44	38	32	21		